

Nominal data

Type	6412 M	
Nominal voltage	VDC	12
Nominal voltage range	VDC	8 .. 15
Speed	min ⁻¹	2850
Power input	W	12.0
Min. ambient temperature	°C	-20
Max. ambient temperature	°C	72
Air flow	m ³ /h	350
Sound power level	B	6.0
Sound pressure level	dB(A)	52

ml = Max. load · me = Max. efficiency · fa = Running at free air · cs = Customer specs · cu = Customer unit
Subject to alterations

Technical features

General description	Housing with earthing lug for bolt M4 x 8 (Torx) Free air power consumption, these values may be considerably higher at the operating point.
Mass	0.760 kg
Dimensions	172 x 150 x 51 mm
Material of impeller	Fibreglass-reinforced plastic (PA)
Housing material	Die-cast aluminium
Direction of air flow	Air exhaust over bars
Direction of rotation	Left, looking at rotor
Bearing	Ball bearings
Lifetime L10 at 40 °C	80000 h
Lifetime L10 at maximum temperature	37500 h
Connection line	Flat plugs 3.0 x 0.5 mm.
Motor protection	Protected against reverse polarity and locking.
Locked-rotor protection	Electronic blocking protection, with electronic motor current limit in the startup phase and when the rotor is blocked.
Approval	VDE, CSA, UL, CE

6412 M

DC axial compact fan

Product drawing

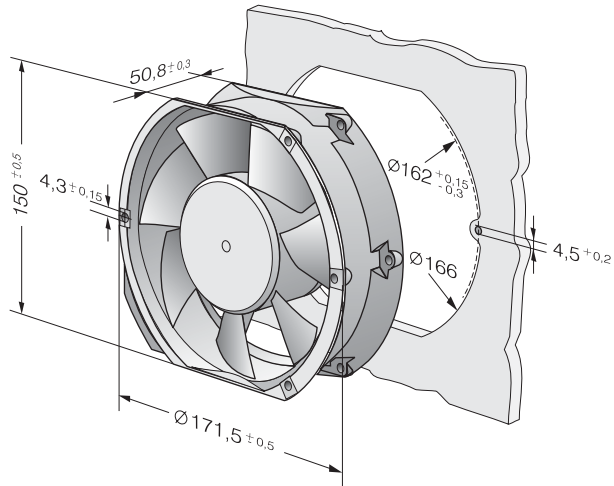

Charts: Air flow

